

CHECKWEIGHER BROCHURE



Warade Packtech Pvt Ltd

14, Dhadge Estate, Survey No.14,
Sinhgad Rd, near Nanded City,
Nanded, Pune, Maharashtra 411041.



www.waradepacktech.com



sales@warade.in



+91 9595701122
+91 8805104700

WARADE[®]
PackTech
We Believe In Creation

COMPACT DESIGN , BIG PERFORMANCE

While overfilling leads to huge production loss, under filling leads to credibility loss and compliance costs.

At Warade, we understand the dilemma and your focus on quality control to avoid these losses, we have developed wide range of high precision dynamic checkweighers that will keep a check on weight, traceability of production statistics and ensure customer satisfaction and brand equity.

CHALLENGES ADDRESSED

UNDERWEIGHT PRODUCT

- Underweight product delivered poses compliance risk & issues.
- Dealing with customer grievances.
- Negative effect on Brand Equity
- High legal cost

OVERWEIGHT PRODUCT

- Increased product giveaway suffers P&L of operations due to more cost & less margins
- Negative effect on cash flows
- Poor cost quality control



FEATURES

- High Precision - Weigh Cell (EMFR Technology) or Load Cell
- Wide Weighing Range - 6 - 50000 gm
- Low & Easy Maintenance
- User Friendly Interface
- CE Certified
- Value for Money

MECHANICAL FEATURES

- Optimum and Sturdy Design
- Easy Integration with Production Lines
- Optimal design for easy spare management
- Models available in SS/MS.
- Adjustable width of conveyor

TECHNICAL SPECIFICATIONS



Specification	Specification	IW 6000
Product Size Range	Length (mm)	80-430
	Width (mm)	30-350
	Height (mm)	10-200
Weighing Range	(gm)	60-15000
Accuracy	(gm)	± 1 to ±3
Max Speed	(ppm)	Upto 60
MOC		M.S. Painted/SS -304
Weighing Device		Load Cell
Temperature Range	° C	5°C - 50°C

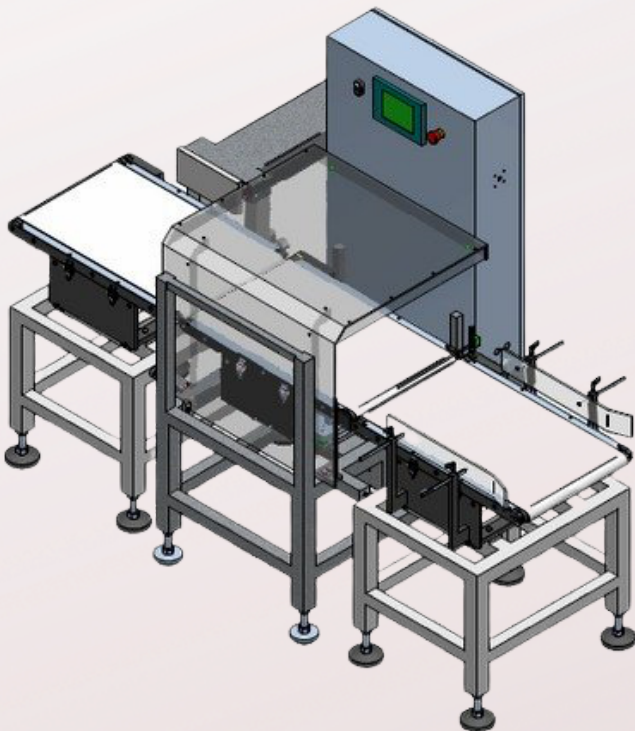

Specification	Specification	IW 15000
Product Size Range	Length (mm)	80-590
	Width (mm)	50-400
	Height (mm)	10-250
Weighing Range	(gm)	30-6000
Accuracy	(gm)	± 5
Max Speed	(ppm)	Upto 35
MOC		M.S. Painted/SS -304
Weighing Device		Load Cell
Temperature Range	° C	5°C - 50°C

*Due to continuous research & development process we reserve right to make modification in design / specification in the equipments

REJECTION SYSTEMS

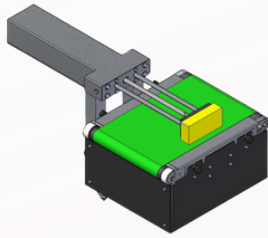

Pusher

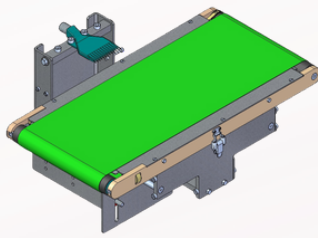

Air Blow

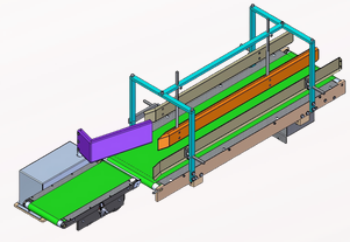

Diverter Arm

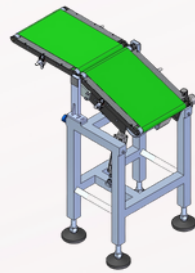

Fall Down

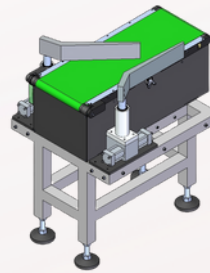

Flipper

ADD-ONS

➤ Remote Monitoring via RS-485 or Ethernet Interface

RS-485 or Ethernet interface enables you to be connected with checkweighers remotely. Once connected remotely you can monitor the system from the pleasure of your desk.

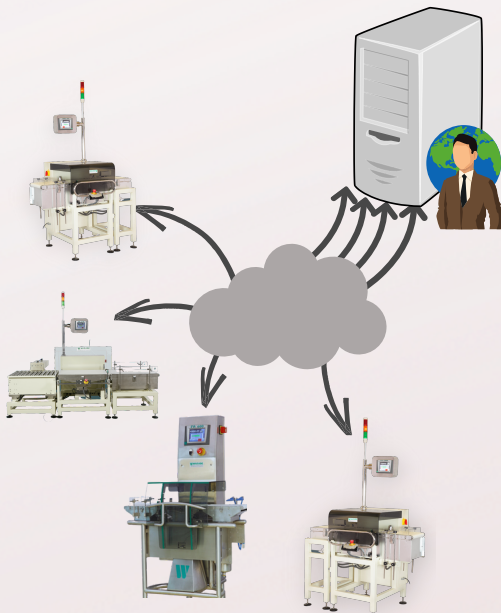

➤ Centralized Remote Monitoring

You can connect all your checkweigher to a central hub through a common network.

This will allow you to monitor data of any checkweigher in network from a central location.

➤ Metal Detection

In addition to check weight, many applications require to check for metallic particle and reject those products that contain them. We provide metal detection technology such that it can be conveniently integrated to weight checking process and then accordingly reject unwanted products. It allows you to minimize your footprint.

➤ Tendency Control / Feedback control

The primary function of any check-weigher is to measure weight. This function can be exploited to our advantage. A check-weigher can be connected to upstream machine to provide feedback on weight.

As the product properties vary during the batches, it becomes extremely difficult to take corrective action to control the packed weight. Tendency control is a tool to minimize the product / production losses in such cases. Our tendency control tool is very flexible to set to suit to the required conditions and send feedback to the primary packing machine.

Based on the feedback, the upstream machine will automatically adjust the weight to the required limits. This way a Checkweigher not only keeps a check on weight but also controls the weight i.e tendency control or feedback control. Even a small saving of 1gm per pouch @ 50ppm line speed, running 20 hrs a day, considering material cost Rs 50/kg can result in saving of 9 lacs/year. Hence, a Checkweigher can save you money.

➤ Printer / Bar code Reader / Label applicator

Printer will print the weight and other production data. The prints find bigger application than just documentation when you need to paste the data on final product such as in warehouse management, identification & traceability.

Our checkweigher has the flexibility to easily add and integrate barcode reader or label applicator in it as per customized application.

➤ Tower Lamp Indicator

Tower lamp indicator on the checkweigher will highlight quickly and easily accept/reject weights within given tolerances. It gives alarm as well as light indication.

Wide range of Applications in multiple industries including :



Food and Dairy

Confectionary, Noodles, Pasta, Coffee, Salad Seasoning, Snacks, Dairy Products, Fish, Flour, Animal Feed & many more.



Pharmaceutical

Tablets, Powder, Bags, Blister Packs, Folding Carton, Syrup Bottle & many more.



Agro chemicals / Industrials

Granules, Fertilizers, Pesticides, Insecticides, Adhesive, Paint & many more.



FMCG

Soap, Detergent, Personal Care, Hygiene Products & many more.



Check Weigher

- High Speed & High Accuracy Checkweighers for bags, boxes, cartons, pouches, vials, tins and containers for multiple industries
- Different dosing & weighing technology depending on product characteristics such as gravity, vibratory, belt & screw feed systems.
- Multiple head systems for even higher speed.



Bagger

- Primary bagging solution for all free flowing bulk material
- Secondary bagging solution of random bagging or neat bagging for sachets and pouches into bags
- Semi-automatic & Fully automatic proven solutions available
- Pick-Fill-Seal solution for premade standee pouches



Case Packer

- Primary, Secondary & Tertiary high speed Cartoning systems
- High positioning accuracy with Robotic Case Packer
- Semi & Fully automatic vertical motion cartoning (VMC) positioned in spices, food, confectionary, MCB industry
- Auto Case Erector for LH & RH type cartons
- Inline Carton Erector can be easily integrated with your cartoning machine



Palletizing

- Advanced palletizing technologies - Robotic, Gantry & High level for Bags, Pails, Trays, Tin and Cases
- High adaptability and flexibility of SKUs with Robotic Palletiser
- Affordable Gantry Palletizer for your SKUs
- Peripherals - Compression conveyor, Pallet dispenser & Stretch Wrapper



Conveying Systems

- We provide customized conveyor & material handling solution upto warehousing with track & trace capability
- We excel at various types of conveying systems - roller, belt, slat, accumulation, telescopic, pencil, gravity, screw, pneumatic, vibrating, flexible, spiral, bucket+
- Efficient Integrated system
- Smooth conveying



SPM

- Tube Packing machine for tapered rollers - Winding & unwinding solutions
- Stocker Conveyor for Mitsubishi Gear Hobbing Machine



EPSM

- Does your project require you to engage with multiple vendors either for machines or for engineering services?
- Does adhoc onsite installation create safety and quality issues?
- Does it take a long time to commission the equipment?
- EPSM that is our turnkey service to get away from these problems
- Single point of contact for Engineering, Supply, Procurement & Management

